



168 mm

07501 - ICOS 2 (IN CAB ON SEAT) PISTOL & MAGAZINE HOLSTERS ADD-ON KIT (1PAIR) INSTALLATION MANUAL

PARTS LIST

- A. Pistol and Magazine Holster - Driver side
- B. Pistol and Magazine Holster - Passenger side
- C. Magazine strap & buckle x2
- D. Pistol strap & buckle x2
- E. M6x1x25mm_ 18-8 Torx Flat head Screw x10

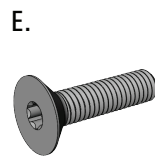
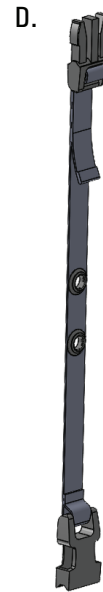
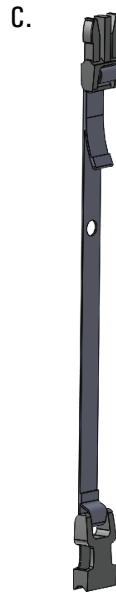
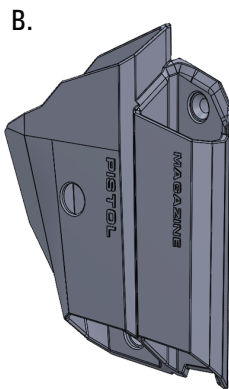
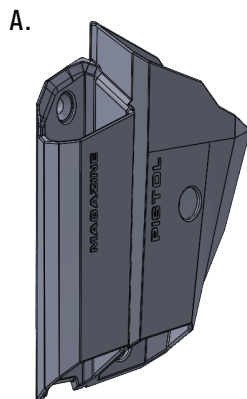

140 mm

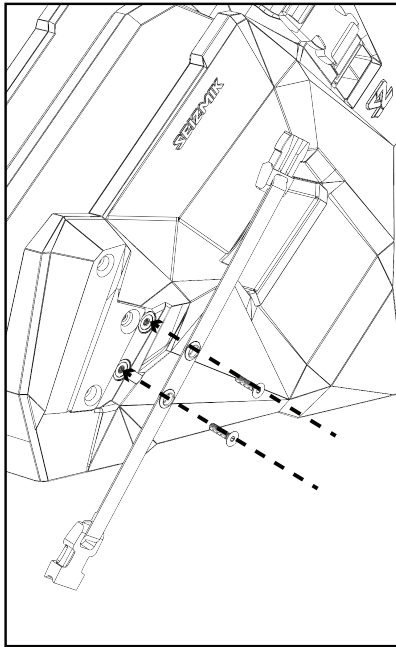

1. Paying attention to the orientation of the buckle, place the Gun Holster Strap with two grommets over the two rearward holes in the side of the ICOS 2 Body using 2 Torx Head Screws. Tighten until snug.

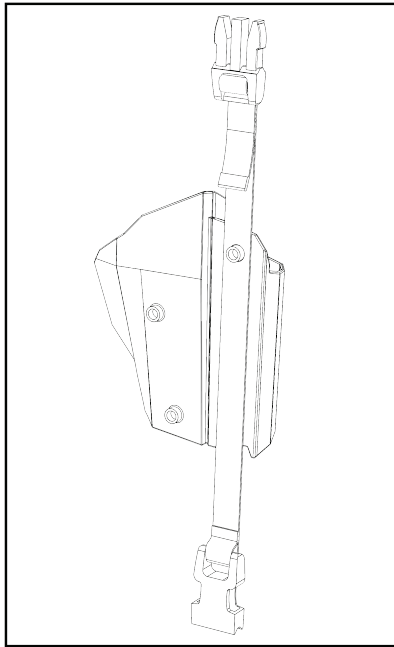

2. Align the Magazine Strap's stitched hole over the forward upper hole on the back side of the Pistol Holster, once again paying attention to the buckle orientation

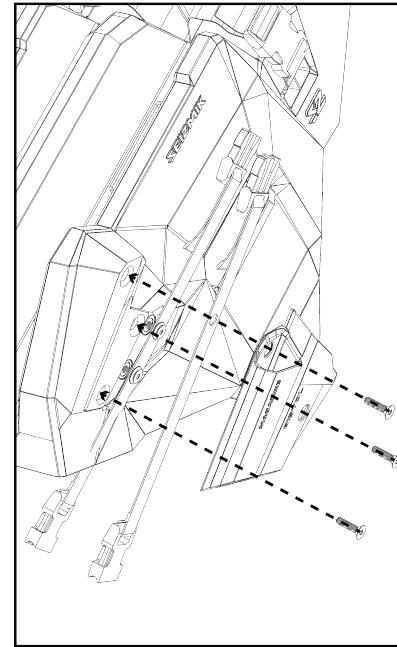

3. Secure the Pistol Holster and Magazine Strap onto the ICOS 2 Body using 3 Torx Head Screws. The Magazine Strap is sandwiched between the Pistol Holster and the ICOS 2 Body. Tighten until snug. Repeat for opposite side.